



**Lighting for hotels, restaurants, cafés,
shop floors and offices**
Versatile ideas for commercial uses





Paulmann – a family business creating lighting ideas for 45 years

Paulmann Licht GmbH was founded in 1978 and is a leading brand manufacturer in the lighting industry. True to our motto "Realise your lighting ideas", we offer our customers high-quality light to make them feel good, and with high energy efficiency – both indoors and outdoors.

We are a German family business based in Springe, Lower Saxony, employing 450 people worldwide and distributing in over 40 countries in Europe. As a member of the UN Global Compact network, we attach great importance to sustainable business practices, environmental protection and social commitment. We are pursuing a programme to reduce the carbon footprint of our sites and products.

Our complete range features over 2,500 luminaires and lamps, for versatile packages with excellent value for money for every application. In particular, the system solutions for 1-phase and 3-phase light rails, recessed luminaires and panels, bathroom luminaires, profile strips and profiles as well as the 24 V "Plug & Shine" plug-in system for outdoor areas enable you as a planner and craftsman to optimally implement the individual wishes of your customers – including Zigbee

luminaires and components for smart control. We are a DIALux premium partner, which means that you benefit from additional planning security and can offer solutions tailored to your customers.

Our in-house designers, constructors and electronics engineers bring together technology, design and user benefits during product development and ensure the high-quality for which Paulmann is rightly famous.

Each of our products is accompanied by Paulmann product experts from the initial idea through to development, manufacture and final delivery. All our items and components are regularly checked by our own in-house Quality Assurance, as well as by external certified test laboratories. That's why we give a 5-year warranty on our Paulmann luminaires and transformers.

Our customers know that they can count on our extensive range and our excellent service: from product to logistics, service to content creation and product presentation.

For this reason, more than 20,000 trade customers throughout Europe rely on Paulmann for their lighting needs:

- Quick and reliable delivery
- High availability of goods
- Goods delivered within 48 hours for customers in Germany and within 72 hours throughout Europe
- Deliveries from quantities of 1
- Low freight-free threshold
- Standardised product data in ETIM format
- Options via EDIFACT: orders, order confirmations, delivery notes, invoices
- Paulmann Academy provides up-to-date product information online
- Expert service team

Content

The perfect range for hotels, restaurants, cafés, shop floors and offices	04
Areas of use	08
Hotels, restaurants and cafés	08
Shop floors	40
Offices and conference rooms	42
Product overview	48
Lamp range	58
Eco Line	58
Smart Home	58
Key	59

The perfect range for hotels, restaurants, cafés, shop floors and offices

Paulmann offers a multi-faceted selection of lighting solutions for commercial uses. Outdoor and entrance area, lobby, bar, waiting or conference room, hotel room, or functional and high-visibility spaces in clinics, law offices, or boutiques: the Paulmann portfolio offers the right solution for any requirements.

Outdoor luminaires for direct connection or as 24-volt system guarantee the illumination of entrances, facades and access paths. Rail systems offer understated illumination for reception areas, brighten hallways, and provide the perfect amount of light for a welcoming ambience over counters or tables.

Ergonomically placed spots, panel luminaires and pendants distribute light with high visual effect where it is needed most in conference rooms or shops. The extensive Pro Strip range with all necessary accessories covers all areas of basic lighting, including indirect coloured light staging.

The Bathroom Selection guarantees premium quality, durability and superior material characteristics for bathroom applications. Table, floor and pendant luminaires round off the look of any interior concept with numerous accent and focal points.

The Paulmann product scope encompasses any and all illumination needs of your customers with state-of-the-art and durable lighting concepts.

Illumination for shop floors

Reception Product Presentation Service & Information Areas

Page 40-41



The perfect range for hotels, restaurants and cafés

Hotel Restaurant Hospitality Outdoor Areas

Page 08-39



Lighting concepts for offices and conference rooms

Reception Office Conference & Meeting Rooms

Page 42-49





Sustainability at Paulmann

Social responsibility, environmental protection and sustainable corporate management play an important role in the Paulmann family business. We have integrated a holistic sustainability strategy into our corporate strategy, which equally includes ecological, economic and social aspects. In this way, we are actively committed to achieving the Sustainable Development Goals (SDGs). We are constantly revising the way we use light and developing lamps and luminaires that enable the economical use of energy and resources. But sustainability at Paulmann doesn't stop with the development and production of our products! At the same time, we are continuing to develop Paulmann's role as a company, and our influence on the three pillars of sustainability.



Social commitment in the region

At Paulmann, we are a family – and this is reflected in the DNA of the family business. Providing equal opportunities and working for the common good are values that are deeply embedded in our culture. We work together to put the health and satisfaction of our employees and customers first.

Our goal is to actively take responsibility for our community and to set a positive example. That is why Paulmann has been supporting various local aid organisations and projects for children and young people in our region.



The mark of responsible forestry



FSC®-certified products contribute to sustainable forestry around the world. The certification ensures that wood-based raw materials for our products come from sustainable and responsible sources only.



Shipping packaging consists of 100% recycled material. Cardboard already accounts for over 90% of product packaging. As of 2023, all new products – where possible – will be packaged completely without plastic.

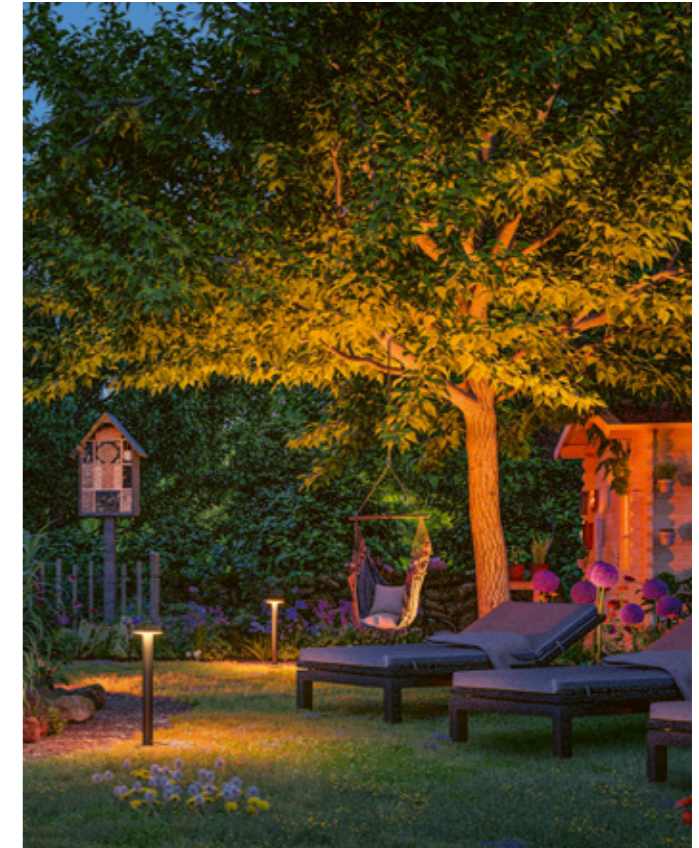

The insect-friendly outdoor luminaire range with 2200 K gold light provides safety and atmosphere while attracting hardly any insects, thus protecting biodiversity.

Ecology – focussing on CO2 reduction

From green electricity and recycling to optimising our sales packaging and shipping processes: step by step, we at Paulmann are working to reduce our CO2 footprint as much as possible.

We want to consistently reduce our emissions and are constantly pursuing our numerous reduction measures – ideally until we achieve net zero emissions. To achieve this, we are focussing our resources and investments on measuring, analysing, avoiding and reducing our emissions. In order to constantly identify further improvements, we calculate our CCF – Corporate Carbon Footprint – annually in accordance with the Greenhouse Gas Protocol. We also aim to support the region where Paulmann has its roots, and so we invest in regional projects and the expansion of our company-wide reduction measures. For example:

- We use green electricity from 100% renewable energy at the company headquarters in Völkzen.
- We are installing e-charging stations and gradually converting our vehicle fleet to e-mobility.
- We are currently planning to build a photovoltaic system at our company headquarters.
- We are constantly optimising our shipping process by saving material and increasing the proportion of recycled material.

Economy and governance – with responsibility and sustainability

We are convinced that responsible and long-term business activities can only be achieved by adhering to fair business practices. Sustainable business operations with high-quality materials, fair wages, career building opportunities for employees, training courses and apprenticeships for the next generation of employees, as well as investment to strengthen the overall business model are just as important for ensuring a holistic sustainability strategy. Paulmann has its roots in the region, and is known as a stable employer. In addition, Paulmann offers a range of apprenticeships, ensuring well-qualified junior staff.

Paulmann wants to systematically create maximum transparency in the supply chain, in accordance with the requirements of the German Supply Chain Act.



As a member of the UN Global Compact, Paulmann publishes an annual progress report on the achievement of the Sustainable Development Goals.



Artemons

ProRail3 pendant
95399 □ p. 52

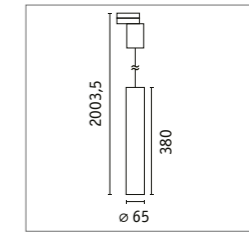

Pure II

ProRail3 spot
95529 □ p. 52

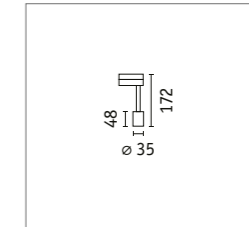

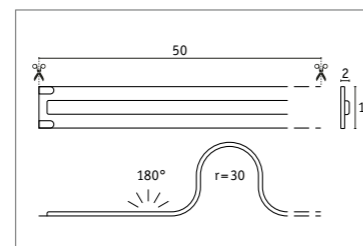
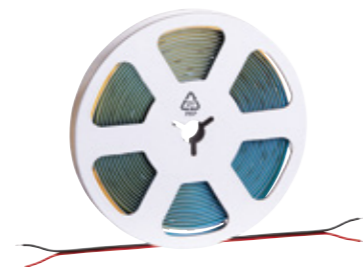

ProStrip
Silver P150
76030 □ p. 51



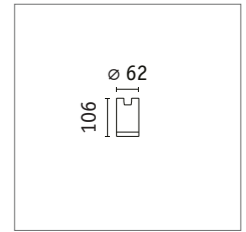

URail Adapter
95553  p. 53



Ketil
Pendant luminaire
50381  p. 55

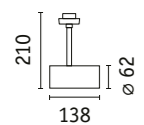
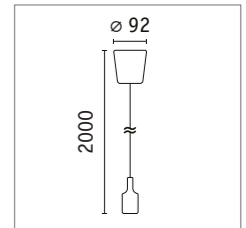

Apol
URail Spot
96979  p. 53



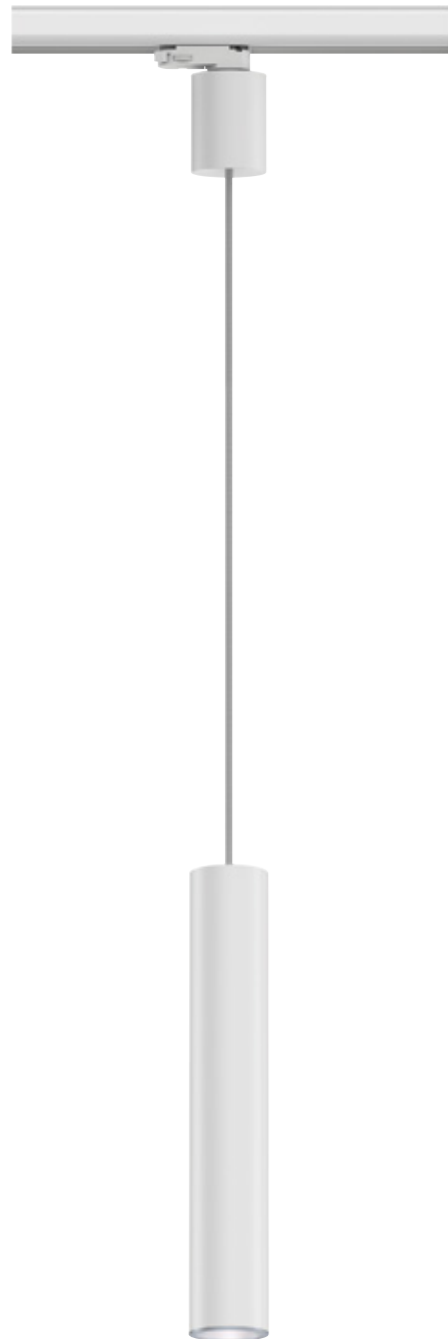

Apol
ProRail3 spot
95410 □ p. 51

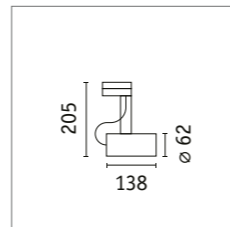

Artemons

ProRail3 pendant
95398 □ p. 52

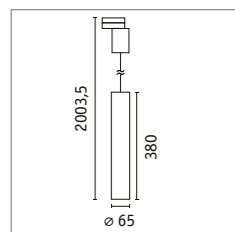

ProStrip – Multi-Zone Control

Silver P75 RGBW
76020 □ p. 51



RGBW Remote
78473



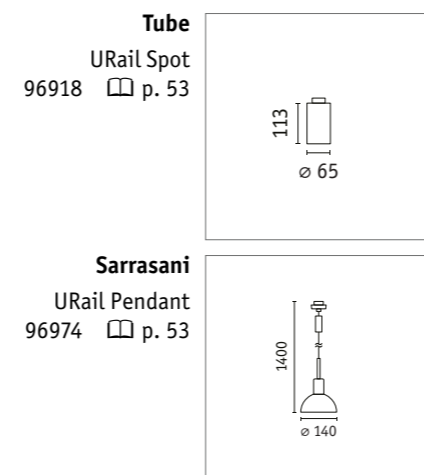
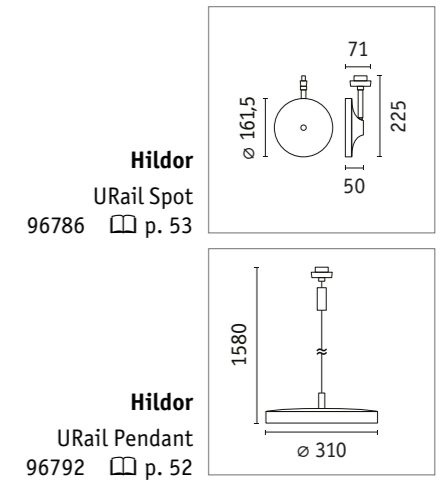

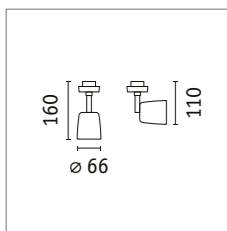

Cole
Recessed luminaire
93397 □ p. 54

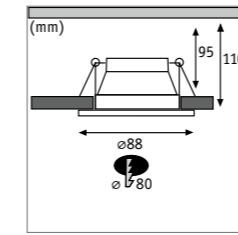

Cover
URail Spot
96926 □ p. 53

ProStrip
Gold P150
78447 □ p. 51

High efficient $\leq 156 \text{ lm/W}$



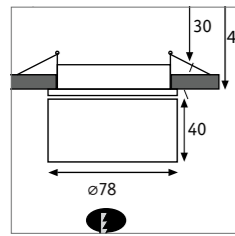

Spircle
Recessed luminaire
93374 □ p. 54



Spircle
Surface-mounted luminaire
93375 □ p. 54

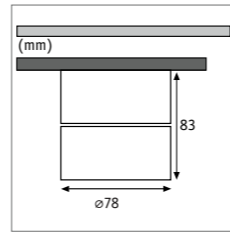

Ranva
Wall luminaire
79508/79506 □ p. 55

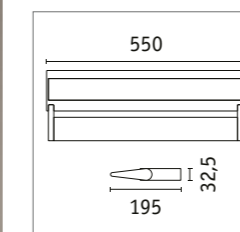



Mingo
Picture luminaire
95565 □ p. 55

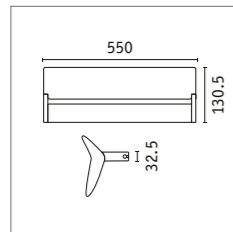
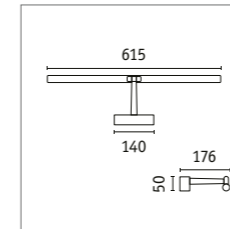

Stine
Wall luminaire
79509/79511 □ p. 55



Egron
Ceiling luminaire
96785 □ p. 54

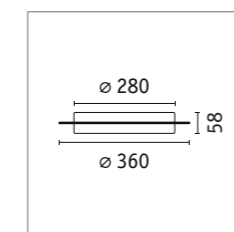

ProStrip
Silver P25
76013 □ p. 51

ProStrip
Silver P150
76021 □ p. 51



High efficient $\leq 156 \text{ lm/W}$

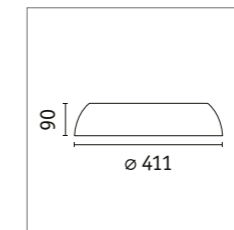

Jaron
Ceiling luminaire
96784 □ p. 54

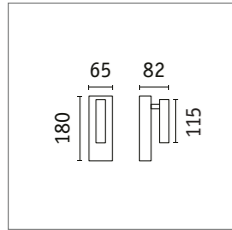

Hulda
Wall luminaire
71108 □ p. 55



Serra
Wall luminaire
71102 □ p. 55

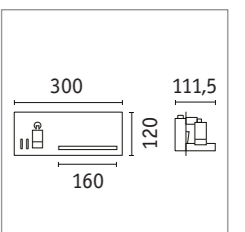

Serra
Wall luminaire
71103 □ p. 55

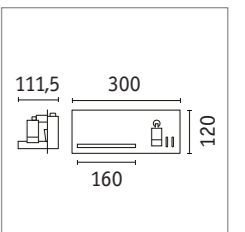

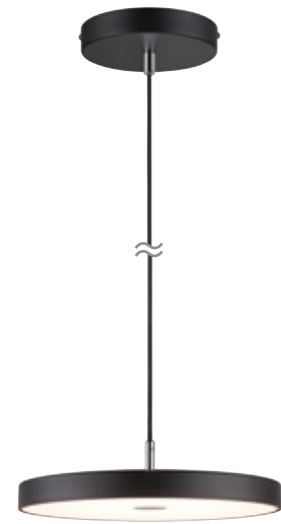

Hildor
Ceiling luminaire
96781 □ p. 54

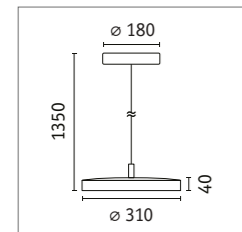
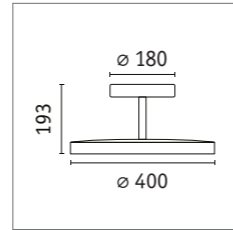

Hildor
Pendant luminaire
96782 □ p. 55



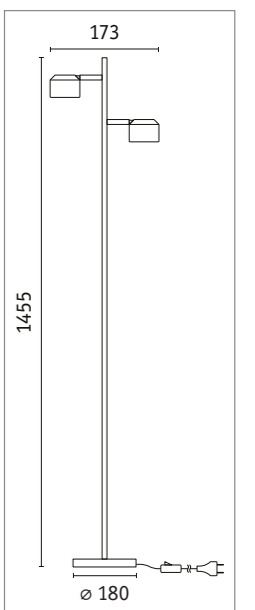

Puric Pane
Floor luminaire
79775 □ p. 55





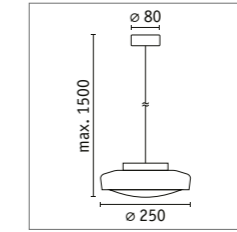

Luena
Pendant luminaire IP44
71080  p. 50

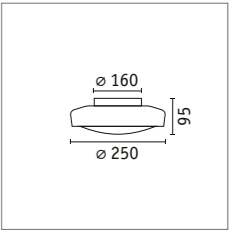

Luena
Ceiling luminaire IP44
71078  p. 50



Luena
Recessed luminaire IP65
71079  p. 50

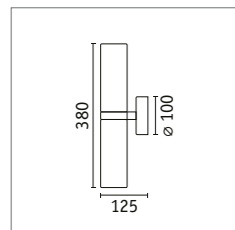
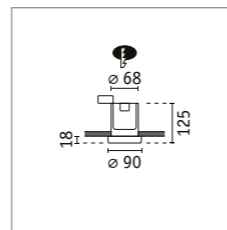

Luena
Wall luminaire IP44
71077  p. 51

Miro

LED mirror IP44
71092 □ p. 50

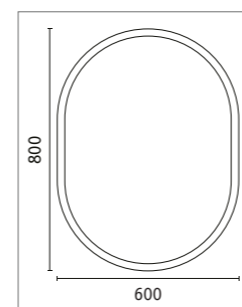
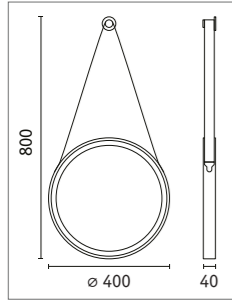

Mirra
LED mirror IP44
71087 □ p. 50





Gove
Pendant luminaire IP44
71066 □ p. 51

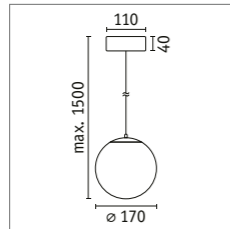

Gove
Wall luminaire IP44
71067 □ p. 50

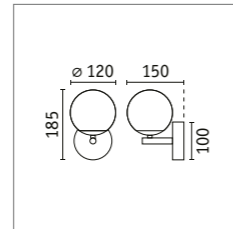

Gove
Wall and ceiling luminaire IP44
71065 □ p. 50

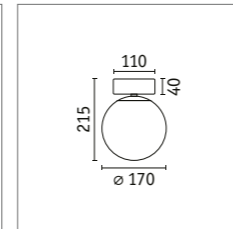

Gove
Wall and ceiling luminaire IP44
71064 □ p. 50

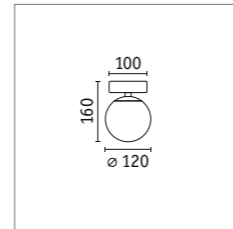

Gove
Wall and ceiling luminaire IP44
71070 □ p. 51

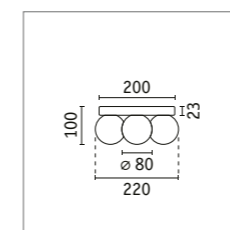
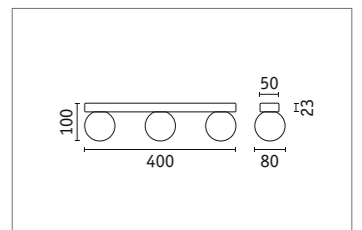

Gove
Wall and ceiling luminaire IP44
71069 □ p. 51



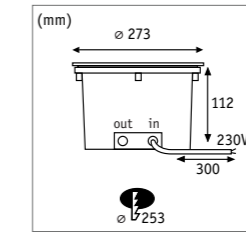

Durea 260
Recessed luminaire IP67
94656 □ p. 56

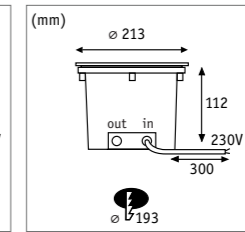

Durea 200
Recessed luminaire
IP67 94655 □ p. 56

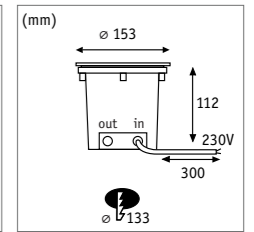

Durea 140
Recessed luminaire IP67
94654 □ p. 56



Vintario
Wall luminaire IP44
94757 □ p. 57

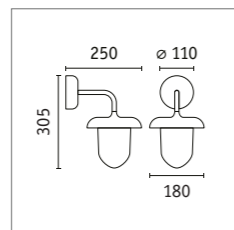

Vintario
Bollard light IP44
94759 □ p. 57

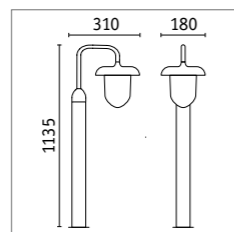

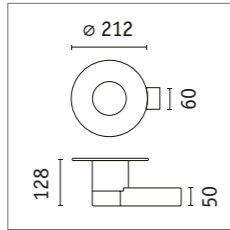

Sienna
Wall luminaire IP44
94834 □ p. 57



Sienna
Bollard light IP44
94835 □ p. 57

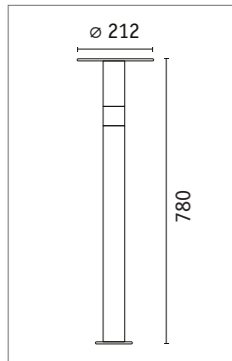

**Plug & Shine
Venea 60**
Bollard light IP44
94674 □ p. 57

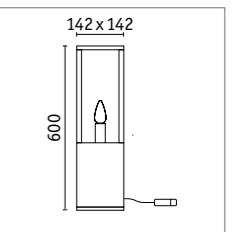



Capea

Wall luminaire IP44
94714 p. 57

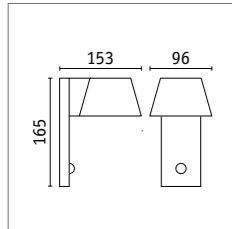

Capea

Bollard light IP44
94715 p. 57

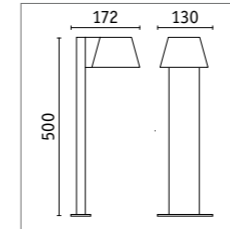

Plug & Shine Globe

Light object IP67
94177 p. 56

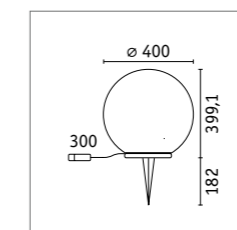

Plug & Shine Globe

Light object IP67
94178 p. 56

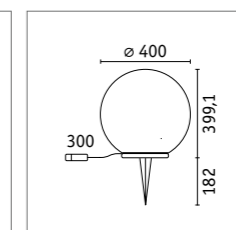

Plug & Shine Globe

Light object IP67
94179 p. 56

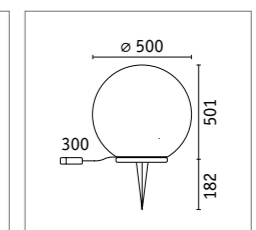



Panel Deck
 ProRail3 spot
 96582 □ p. 52

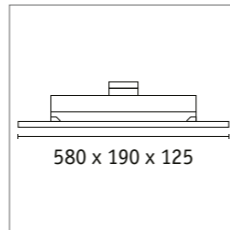

Kratos
 ProRail 3 spot
 96573 □ p. 52

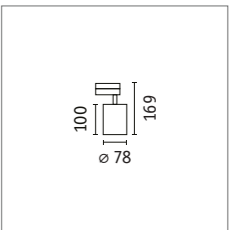

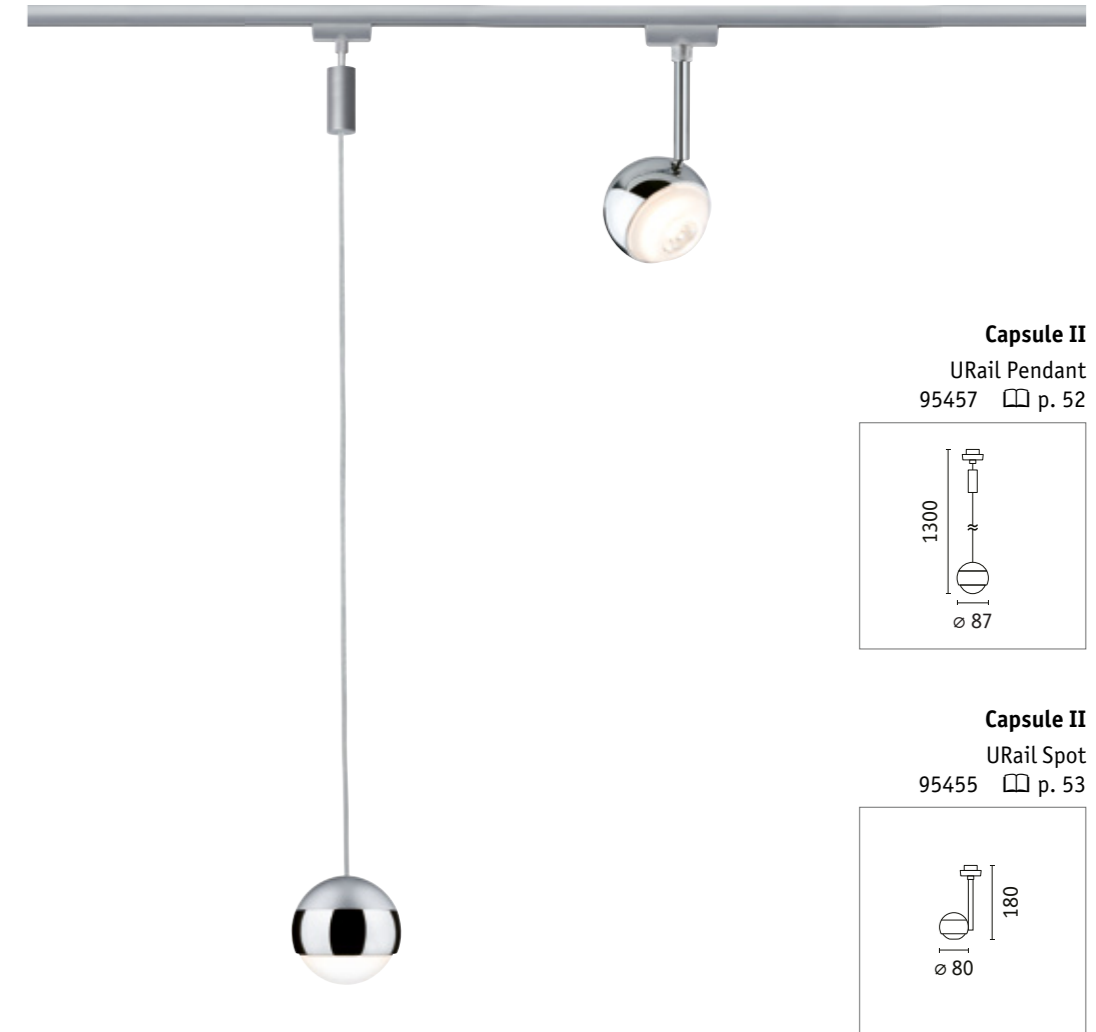

Veluna VariFit Edge
Recessed panel luminaire IP44
79956 □ p. 50

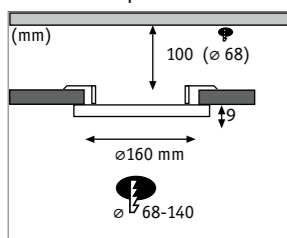

Veluna VariFit Edge
Recessed panel luminaire IP44
79957 □ p. 50

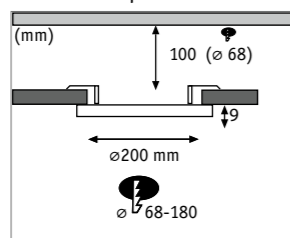



Corus
URail Pendant
95401 □ p. 53

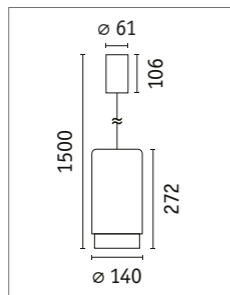

Zeuz
URail Spot
95537 □ p. 52

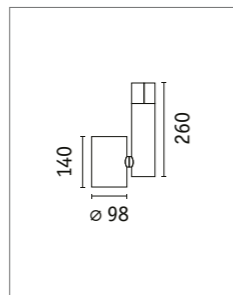

Panel Deck
ProRail3 spot
96583 □ p. 52

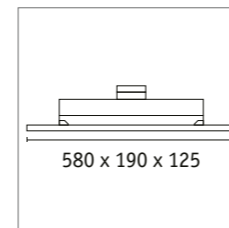



Lento
Ceiling luminaire
79693 □ p. 55

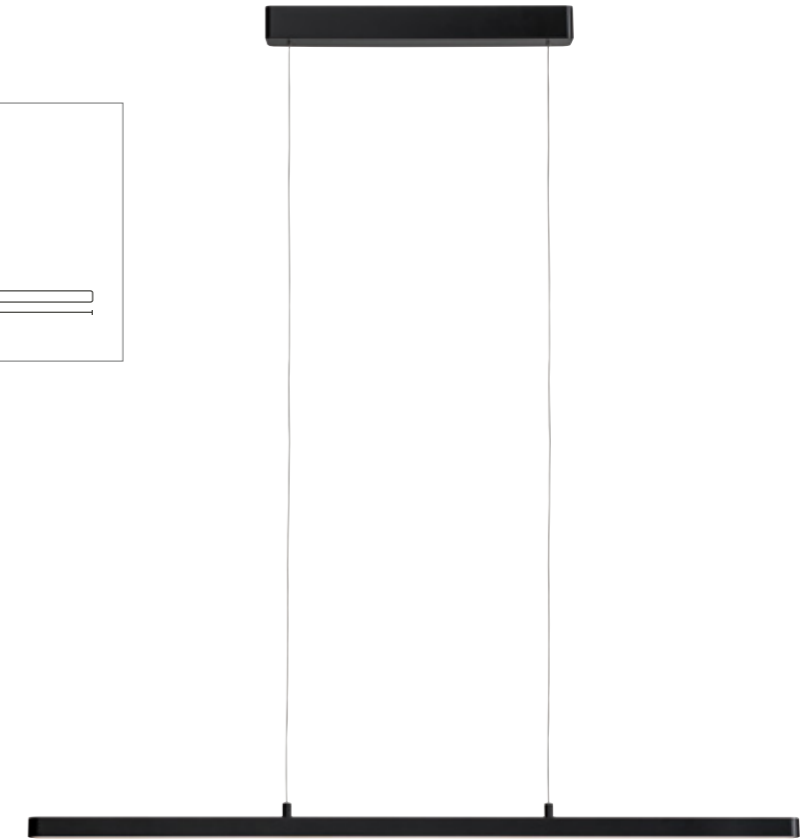
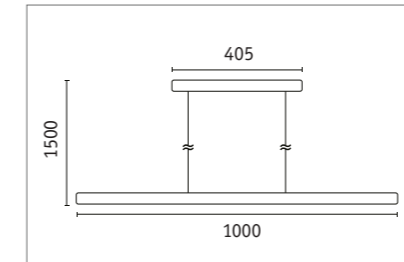

Areo VariFit
Recessed panel luminaire
79966 □ p. 54

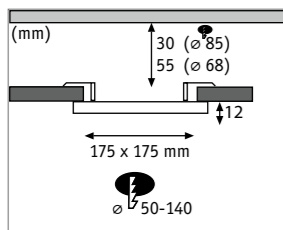

Areo VariFit
Recessed panel luminaire
79967 □ p. 54

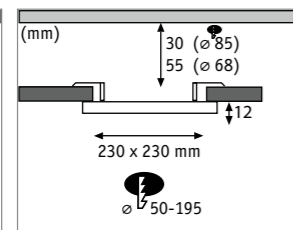

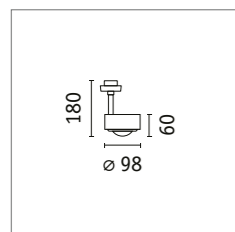

Aldan
URail spot
95519 □ p. 53

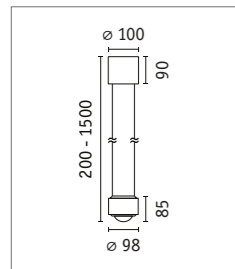

Aldan
URail pendant
95520 □ p. 52

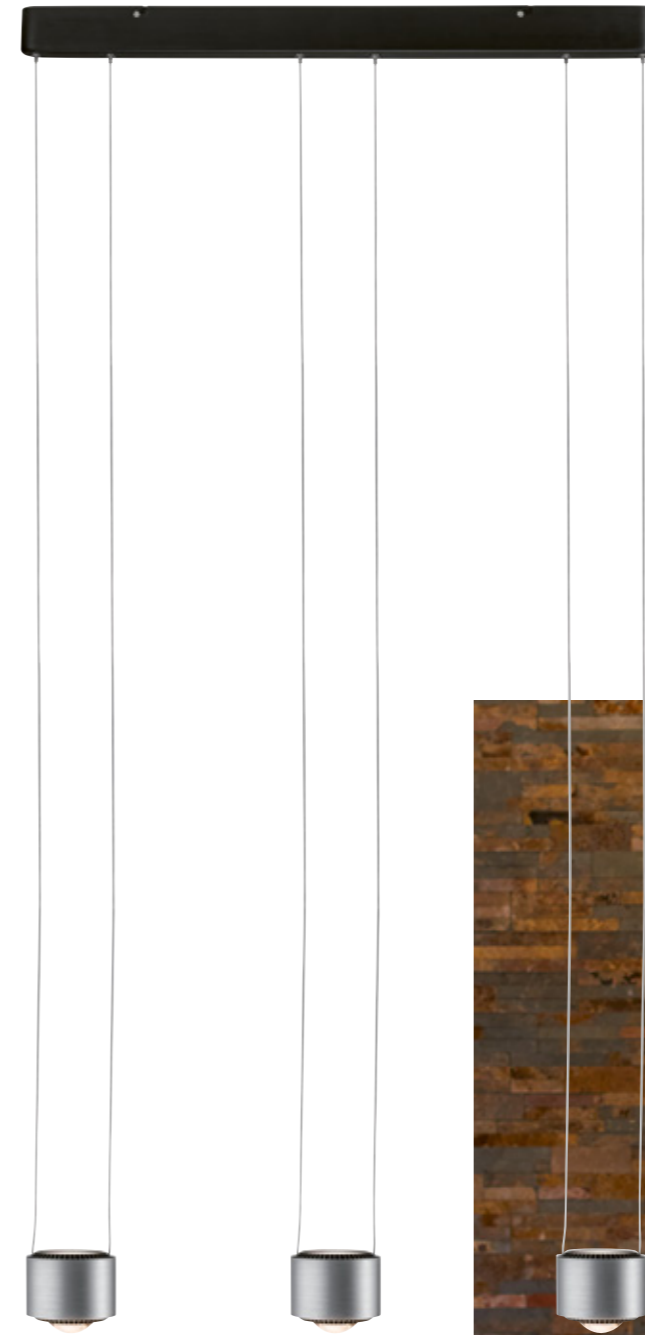

Aldan
Pendant luminaire
79720 □ p. 55

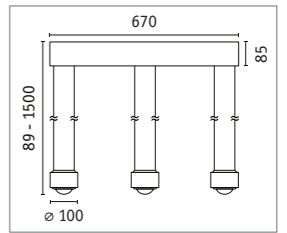

Bathroom applications

The Bathroom Selection guarantees premium quality, durability and superior material characteristics for bathroom applications.

Paulmann offers a complete product range for bathrooms with high-quality products at attractive prices. All items have at least IP44 protection, making them ideal for use in bathrooms.

All products for bathroom applications can be found in our dedicated brochures.



Luena
Ceiling luminaire
incl. 1x11,5 W
600 lm, 3.000 K
230 V
⌀95 ø250 mm
71078



Luena
Recessed luminaire
max. 35 W, GU10
230 V
⌀125 ø90 mm
71079



Veluna VariFit Edge
Recessed panel luminaire
incl. 1x15,5 W
1.000 lm, 3.000–6.500 K
230 V
⌀9 ø160 mm
79956



Veluna VariFit Edge
Recessed panel luminaire
incl. 1x18 W
1.400 lm, 3.000–6.500 K
230 V
⌀9 ø200 mm
79957



Miro
LED mirror
incl. 1x7,5 W
200 lm, 2.700–6.500 K
230 V
ø400 ø40 mm
71092



Mirra
LED mirror
incl. 1x22 W
1.400 lm, 3.000–6.500 K
230 V
⌀800 ø600 ø27 mm
71087



Gove
Pendant luminaire
incl. 1x9 W
900 lm, 3.000 K
230 V
⌀1.500 mm ⌀30-150 cm
ø170 mm
71066



Luena
Pendant luminaire
incl. 1x11,5 W
600 lm, 3.000 K
230 V
⌀150-50 cm ø250 mm
71080



Gove
Wall and ceiling luminaire
incl. 1x5 W
400 lm, 3.000 K
230 V
⌀160 ø120 mm
71064



Gove
Wall and ceiling luminaire
incl. 1x9 W
900 lm, 3.000 K
230 V
⌀215 ø170 mm
71065



Gove
Wall luminaire
incl. 1x5 W
400 lm, 3.000 K
230 V
⌀185 ø120 ø150 mm
71067



Gove
Wall and ceiling luminaire
max. 3x20 W, G9
230 V
⌀100 ø220 mm
71069



Gove
Wall and ceiling luminaire
max. 3x20 W, G9
230 V
⌀100 ø400 ø80 mm
71070



Luena
Wall luminaire
max. 2x20 W, E14
230 V
⌀100 ø380 ø125 mm
71077

Pro Strips

Professional quality 24 V LED strip range for indoor use

The Paulmann Pro Strip range includes professional-quality LED strips in silver and gold, matching accessories like controllers and transformers, as well as a wide range of connectors and profiles.

All topics of indirect coloured light staging, including basic lighting, are therefore covered.

We call it our all-round range for professional interior lighting projects.

All LED ProStrip products can be found in our dedicated brochures.



Silver P150
LED Strip
1270 lm/m, 88,2 lm/W,
3.000 K, ⚡ 120°
DC 24 V
⌀5 m
76030

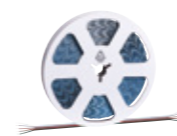

Silver P75 RGBW
LED Strip
700 lm/m, 79,5 lm/W,
3.000 K, ⚡ 120°
DC 24 V
⌀5 m
76020

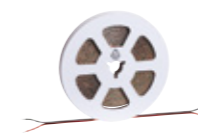

Gold P150
LED Strip
1600 lm/m, 127 lm/W,
4.000 K, ⚡ 120°
DC 24 V
⌀5 m
78447



Silver P150
LED Strip
1500 lm/m, 1520 lm/W,
2.700 K, ⚡ 120°
DC 24 V
⌀5 m
76021

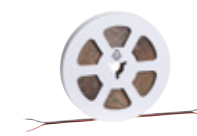

Silver P25
LED Strip
400 lm/m, 100 lm/W,
2.700 K, ⚡ 120°
DC 24 V
⌀5 m
76013

High efficient
≤156 lm/W

High efficient
≤156 lm/W

Rail systems

Rail systems offer understated illumination for reception areas, brighten hallways, and provide the perfect amount of light for a welcoming ambience over counters or tables. Ergonomically placed spots, panel luminaires and pendants distribute light with high visual effect where it is needed most in conference rooms or shops.

The versatile Paulmann ProRail3 rail system is a true all-rounder in terms of flexibility and customised lighting. Bright illumination is guaranteed – even in rooms with many angles and only a single power outlet.

The single-phase URail system is a true multi-talent for a great variety of solutions. The system is highly versatile and will allow virtually any configuration using its broad selection of system components.

All ProRail3 and URail products can be found in our dedicated brochures.



Pendant Sarrasani

URail Pendant
max. 20W, E14
230V
↑140 cm ø140 mm
96974

Pendant Corus

URail Spot
max. 50W, E27
230V
↑272 mm ↑150 cm
ø140 mm
95401

Spot Aldan

URail Spot
incl. 1×8W
498 lm, 2.700 K
↙ 65°
230V
↑170 ø98 mm
95519

Spot Hildor

URail Spot
incl. 1×15W
● 850 lm, 3.000 K
○ 850 lm, 4.000 K
230V
↑225 ø162 ⇄71 mm
● 96789 ○ 96786

Spot Tube

URail Spot
max. 10W, GU10
230V
↑112 ø65 mm
96918



Spot Apol

ProRail3 Spot
max. 50W, E27
230V
↑205 ø62 ⇄138 mm
B 95411 W 95410

Spot Kratos

ProRail3 Spot
incl. 1×25W
3.000 lm, 3.000 K
↙ 50°
230V
↑142 ⇄158 ↗132 mm
96573

Spot Zeus

ProRail3 Spot
incl. 1×33W
3.680 lm, 4.000 K
↙ 60°
230V
↑241 ⇄176 ↗98 mm
91350

Spot Pure II

ProRail3 Spot
max. 1×10W
230V
↑172 ø35 mm
95529

Panel Deck

ProRail3 Spot
incl. 1×75W
● 6.600 lm, 3.000 K
○ 7.000 lm, 4.000 K
↙ 90°
230V
↑125 ⇄580 ↗190 mm
● 96582 ○ 96583



Spot Apol

URail Spot
max. 50W, E27
230V
↑195 ø62 ⇄138 mm
96979

Spot Capsule II

URail Spot
incl. 1×6,3W
439 lm, 2.700 K
↙ 30°
230V
↑210 ⇄80 ↗80 mm
95455

Spot Cover

URail Spot
max. 10W, GU10
230V
↑140 ⇄58 ↗90 mm
96926

Spot Zeus

URail Spot
incl. 1×33W
2.770 lm, 3.000 K
↙ 39°
230V
↑260 ⇄176 ↗98 mm
95537

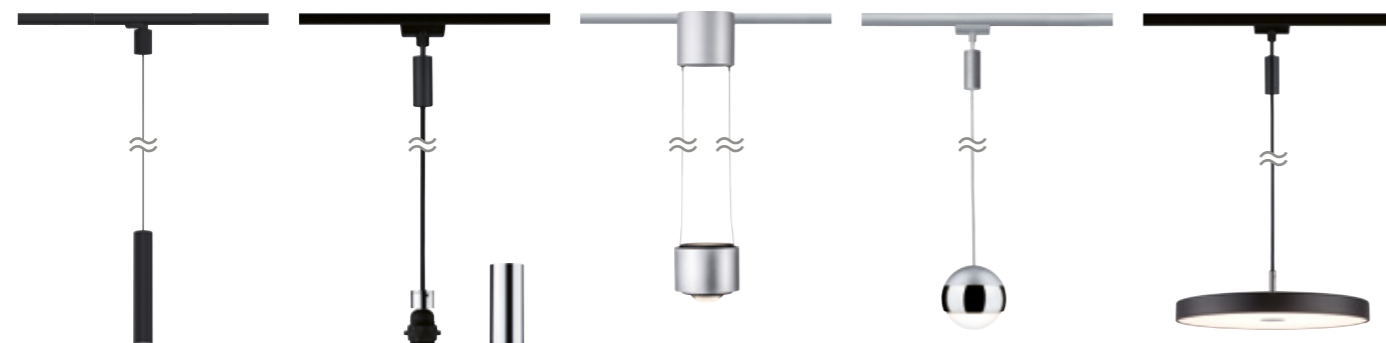

Pendant Artemons

URail Pendant
max. 10W, GU10
230V
↑380 mm ↑150 cm
ø65 mm
B 95399 W 95398

2Easy Basic Pendant

URail Pendant
max. 20W, E27
230V
↑150 cm ⇄87 mm
↗87 mm
96919

Pendulum Aldan

URail Pendant
incl. 1×8,5 / 1×4,5 W
820 lm, 2.700 K
230V
↑85 mm ↑20-150 cm
ø98 mm
95520

Pendulum Capsule II

URail Pendant
incl. 1×6,3 W
439 lm, 2.700 K
230V
↑130 cm ø87 mm
95457

Pendant Hildor

URail Pendant
incl. 1×15W
● 850 lm, 3.000 K
○ 850 lm, 4.000 K
230V
↑1.580 mm ↑150 cm
ø310 mm
● 96792 ○ 96798



URail Adapter

max. 100W
230V
↑106 ø62 mm
95553

Luminaires

Paulmann offers a multi-faceted selection of lighting solutions for commercial uses.

The Paulmann product scope encompasses any and all illumination needs of your customers with state-of-the-art and durable lighting concepts.



Eggon
Ceiling luminaire
incl. 1x16 W
750 lm, 2.700 K
230 V
⌀58 ⌀360 mm
96785



Hildor
Ceiling luminaire
incl. 1x26,5 W
2.100 lm, 2.700 K
230 V
⌀193 ⌀400 mm
96781



Jaron
Ceiling luminaire
incl. 1x26,5 W
1.900 lm, 2.700 K
230 V
⌀90 ⌀410 mm
96784



Spiracle
Recessed luminaire
incl. 1x8 W
550 lm, 3.000 K
⊂ 36°
230 V
⌀78 mm
93374



Spiracle
Surface-mounted luminaire
incl. 1x8 W
550 lm, 3.000 K
⊂ 36°
230 V
⌀83 ⌀78 mm
93375



Areo VariFit
Recessed panel luminaire
incl. 1x13 W
1.200 lm, 3.000–6.500 K
230 V
⌀12 ⌀175 ⌀175 mm
79966



Areo VariFit
Recessed panel luminaire
incl. 1x16 W
1.400 lm, 3.000–6.500 K
230 V
⌀12 ⌀230 ⌀230 mm
79967



Cole
Recessed luminaire
max. 1x10 W, GU10
230 V
⌀110 ⌀88 mm
93397



Mingo
Picture luminaire
incl. 1x11 W
810 lm, 3.000 K
230 V
⌀50 ⌀615 ⌀175 mm
95565



Serra
Wall luminaire
incl. 1x5,5 / 1x2,6 W
520 + 180 lm, 2.700 K
230 V
⌀120 ⌀300 ⌀111,5 mm
71102



Serra
Wall luminaire
incl. 1x5,5 / 1x2,6 W
520 + 180 lm, 2.700 K
230 V
⌀120 ⌀300 ⌀111,5 mm
71103



Hulda
Wall luminaire
incl. 1x2,5
130 lm, 3.000 K
230 V
⌀180 ⌀65 ⌀82 mm
71108



Aldan
Pendant luminaire
incl. 3x4,8 / 3x4,4 W
1.570 lm, 2.700 K
230 V
⌀85 mm ⌀8,9-150 cm
⌀100 mm ⌀670 mm
79720



Hildor
Pendant luminaire
incl. 1x22 W
1.600 lm, 2.700 K
230 V
⌀1.350 mm ⌀300-
1.350 cm ⌀310 mm
96782

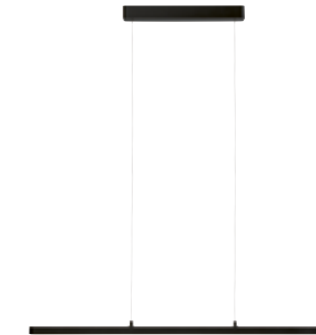

Lento
Pendant luminaire
incl. 1x42 W
1.800 lm, 2.700 K
230 V
⌀25 mm ⌀6,7-150 cm
⌀1.000 mm ⌀35 mm
79693



Ketil
Pendant luminaire
max. 1x60 W, E27
230 V
⌀2.000 mm ⌀92 mm
50381



Puric Pane
Floor luminaire
incl. 2x3 W
300 lm, 2.700 K
230 V
⌀1450 ⌀86 ⌀173 mm
79775



Ranva
Wall luminaire
incl. 1x13 / 1x2 W
800 lm, 2.700 K
⊂ 107°, 230 V
⌀33 ⌀550 ⌀195 mm
B 79505 W 79506



Ranva
Wall luminaire
incl. 1x13 W
800 lm, 2.700–6.500 K
⊂ 107°, 230 V
⌀33 ⌀550 ⌀195 mm
B 79507 W 79508



Stine
Wall luminaire
incl. 1x13 / 1x4 W, 970 lm,
2.700 K
⊂ 102°, 230 V
⌀171 ⌀550 ⌀131 mm
B 79509 W 79510



Stine
Wall luminaire
incl. 1x13 W, 970 lm,
2.700–6.500 K
⊂ 102°, 230 V
⌀171 ⌀550 ⌀131 mm
B 79511 W 79512



Comprehensive outdoor lighting solutions

Our highly reliable outdoor luminaires either come equipped with state-of-the-art LED technology, or you can choose any lamp you like. Their timeless, modern design, combined with superior quality, is a perfect choice for discerning private or business customers.

The complete range encompasses 230V LED luminaires, the super versatile 24V Plug & Shine system, as well as solar-powered and in part mobile luminaires with full independence of any power outlet.

All products for outdoor applications can be found in our dedicated brochures.



Durea 140
Recessed luminaire
incl. 1x8W
530 lm, 3.000 K
∠ 75°
230V
∅112 ∅153 mm
94654



Durea 200
Recessed luminaire
incl. 1x12,5W
870 lm, 3.000 K
∠ 60°
230V
∅112 ∅213 mm
94655



Durea 260
Recessed luminaire
incl. 1x15W
1.040 lm, 3.000 K
∠ 80°
230V
∅112 ∅273 mm
94656



Plug & Shine Globe
Light object
incl. 1x2,8W
160 lm, 3.000 K
24V
∅200 mm
94177



Plug & Shine Globe
Light object
incl. 1x6,5W
620 lm, 3.000 K
24V
∅400 mm
94178



Plug & Shine Globe
Light object
incl. 1x6,5W
620 lm, 3.000 K
24V
∅500 mm
94179



Sienna
Wall luminaire
incl. 1x9 / 1x3 W
500 lm, 3.000 K
230V
∅128 ∅212 ∅247 mm
94834



Vintario
Wall luminaire
max. 20W, E27
230V
∅305 ∅180 ∅250 mm
94757



Caepa
Wall luminaire
incl. 1x6W
550 lm, 2.200 K
∠ 98°
230V
∅56 ∅96 ∅128 mm
94713



Caepa
Wall luminaire
incl. 1x6W
450 lm, 2.200-3.000 K
∠ 98°
230V
∅165 ∅96 ∅153 mm
94714



Sienna
Bollard light
incl. 1x9W
400 lm, 3.000 K
230V
∅780 ∅212 ∅212
∅247 mm
94835



Vintario
Bollard light
max. 20W, E27
230V
∅1.135 ∅180 ∅310 mm
94759



Caepa
Bollard light
incl. 1x6W
450 lm, 2.200 K
∠ 98°
230V
∅500 ∅130 ∅172 mm
94715



Plug & Shine Venea 60
Bollard light
incl. 1x2W, E14
140 lm, 1.900 K
24V
∅600 ∅142 ∅142 mm
94674

Lamp range

A variety of shapes & technologies

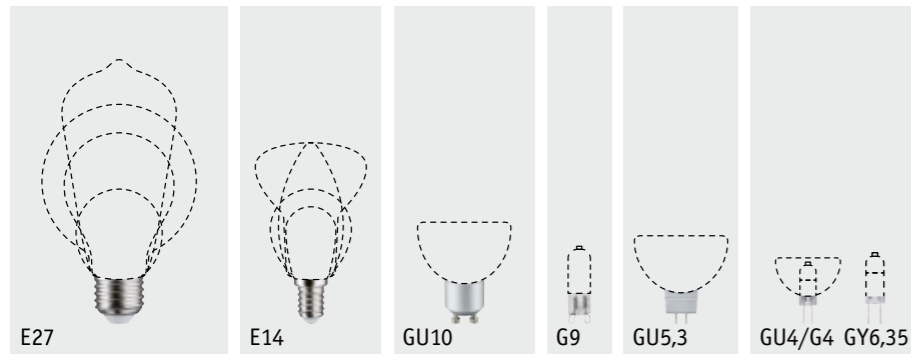

Perfect illumination depends on choosing the right lamps. The base, model, expected brightness in lumen or dimmability are all important aspects to be considered in lighting concepts. Paulmann offers an attractive selection of lamps for any application.

Eco Line

Ultra energy-efficient LED lamps

These lamps combine innovation and sustainability: Increasing system efficiency to up to 210 lm/W is the next significant development in LED lamps. It allows them to be classified in energy efficiency class A on the new scale.

Lamps are available in warm white and neutral white.

High savings potential, thanks to low energy consumption:

- 95% saving, compared to conventional incandescent light bulbs
- 60% energy saving, compared to SMD LED lamps
- 45% energy saving, compared to standard LED filament lamps

Reduction of material waste:

Eco Line lamps have a service life of 50,000 h, making them 3.5x more durable than a comparable filament lamp and therefore drastically reduce cost and effort for lamp replacements, as well as material waste.



Smart Home

Lighting control via app, voice command, or remote control

The Zigbee RF standard allows convenient lighting control via the Zigbee 3.0 gateway, or manually via smart control elements like a remote control or wall switch. Paulmann offers the broadest single-source selection of smart luminaires, lighting systems, lamps, and accessories.

Key

Light characteristics

Lumen (lm)	Lumen (lm) is the unit of measure for luminous flux. Luminous flux is the total amount of light emitted by the lamp.
Watt (W)	Physical unit of output.
Kelvin (K)	The light colour of a lamp is described by the term "colour temperature". The unit of measure for colour temperature is Kelvin (K).
Warm white ●	Warm white light (between 2700 and 3000 Kelvin): warm white light is similar to natural light at sunset. The redder the light, the more relaxing it feels.
Neutral white ○	Neutral white light (between 3300 and 5300 Kelvin): this type of light creates "functional" lighting. A great choice for the kitchen or bathroom.
Zigbee 	Voice and app control via Zigbee 3.0 gateway

Quality & safety

DIALux

All bathroom luminaires in this catalogue are listed in Dial's professional DiaLux lighting design range

Five-year warranty

5 Jahre Year Ans
Jaar Años Annos
Garantie

In addition to a statutory warranty, Paulmann Licht GmbH also guarantees the correct functioning of Paulmann brand products for a period of five years after purchase, when used as intended and subject to an average operating time of max. 4500 h/year after professional installation.

You can find the complete warranty conditions at www.paulmann.com/guarantee

All illustrations and information regarding dimensions, colours, etc. are subject to possible production tolerances and are non-binding. We reserve the right to make changes to products at any time.

Shortened illustration

≈ = All luminaires shown with this icon have a shortened illustration. In reality, the cables are longer.



Colour code

CM Chrome matt

B Black

W White

P

Paulmann

You will find more products in our brochures:

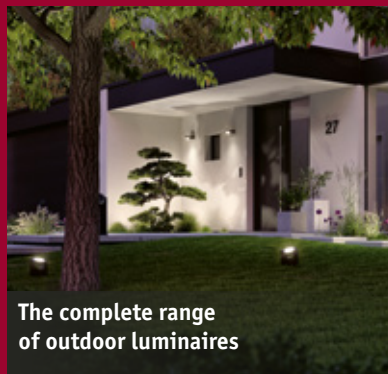
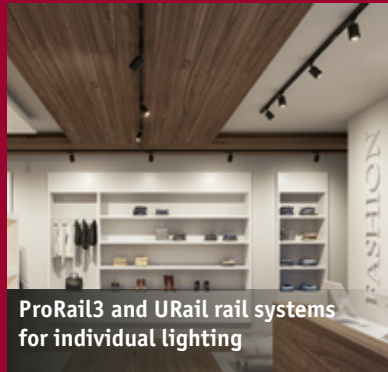

Contact Germany
Paulmann Licht GmbH
Quezinger Feld 2
31832 Springe Völksen
Phone: +49 5041 998 317
fachvertrieb@paulmann.de